

MEUBLES
DEMEYERE

SAV
SPAREPARTS
KUNDEDIENST
POST VENTAS
SERVICE NA VERKOOP
SERVIZIO POST-VENDITA
SERVICO DEPOIS DE VENDA
SERWIS POGWARANCYJNY

137197 0

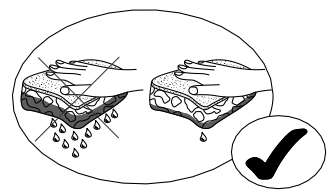
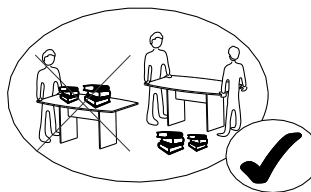
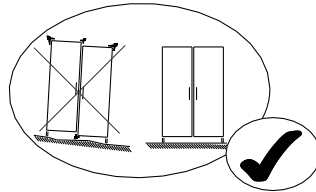
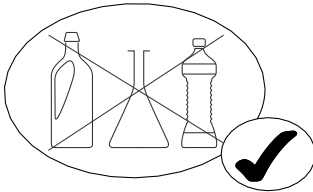

Français:

Notice à conserver.

En cours du montage, prenez garde aux risques de pincement et de cisaillement.

Ne pas mettre le lit à proximité d'une source de chaleur.

Ne pas s'asseoir à plusieurs sur le lit.

Ne pas sauter sur le lit.

Stocker le lit dans un endroit sec.

English:

Retain the instructions for future reference.

During the assembly, beware the risks of pinching and shearing.

Keep the product away from heat sources.

Do not sit on the bed several.

Do not jump on the bed.

Store the bed in a dry place.

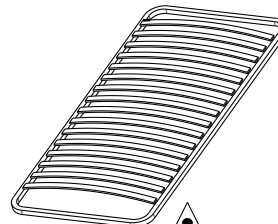

NON INCLU
NOT SUPPLIED



Dimension du sommier
cadre métallique à lattes
The metal frame Slatted
bed base dimension

90x190 cm

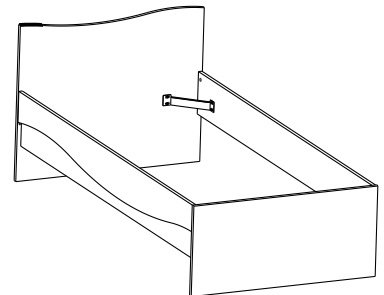
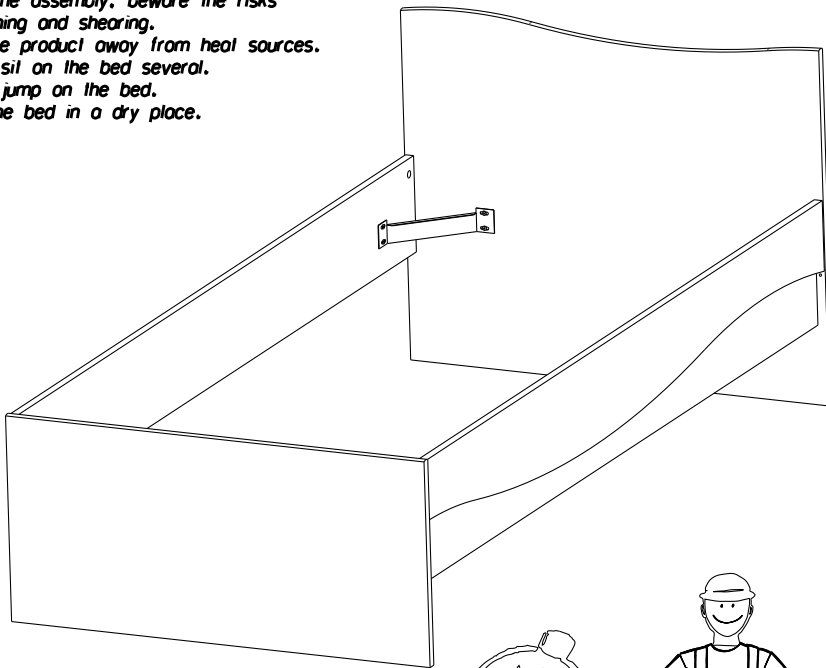

0H 45MN



- FR** SECURITE
RESPECTER LES INSTRUCTIONS DE MONTAGE DECRIRES DANS LA NOTICE.
- EN** CAUTION
FOLLOW CAREFULLY THE ASSEMBLING INSTRUCTIONS DESCRIBED IN THE DIRECTIONS.
- DE** SICHERHEITSVORSCHRIFTEN
BEACHTEN SIE BITTE UNBEDINGT DIE ANGEGEBENEN AUFBAUVORSCHRIFTEN.
- ES** SEGURIDAD
RESPECTAR LAS INSTRUCCIONES DE MONTAJE DESCRIBIDAS EN EL FOLLETO.

- NL** VEILIGHEID
DE IN DE GEBRUIKSAANWIJZING BESCHREVEN INSTRUCTIES RESPECTEREN.
- IT** SICUREZZA
RISPETTARE LE ISTRUZIONI DI MONTAGGIO DESCRITTE NEEL 'AVVERTENZA.
- PT** SEGURANCA
RESPEITAR AS INSTURACOS DE MONTAGEM DESCRIVEDAS NA INSTRUCOES DE USO.
- PL** UWAGA
PROSZE PRZESTRZEGAC INSTRUCJI MONTAZU.

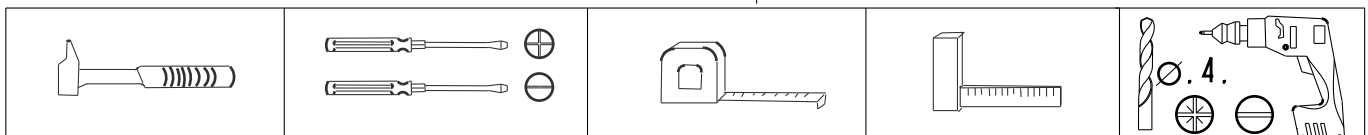

REP	DIM	QTE
1	940 x 758	1
2	940 x 440	1
3	1902 x 205	1
4	1902 x 205	1
5	1902 x 159	1

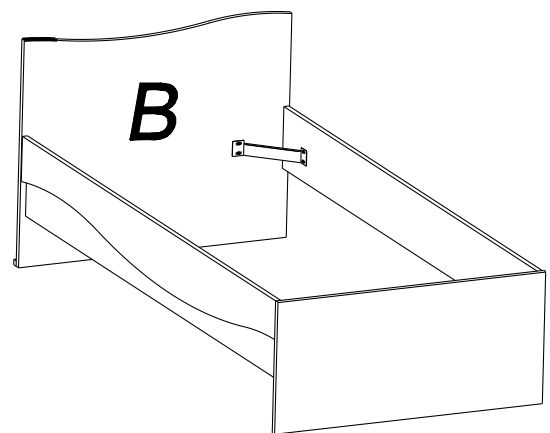
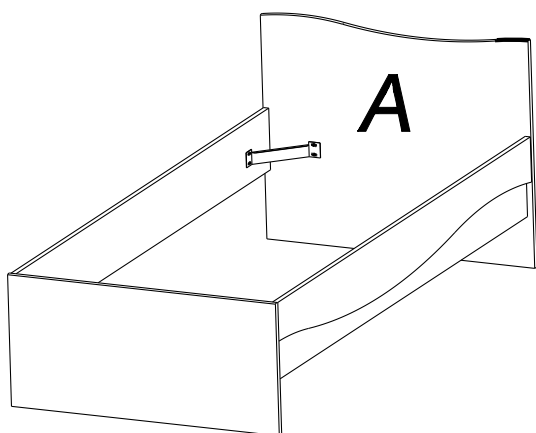
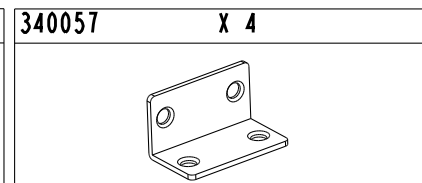
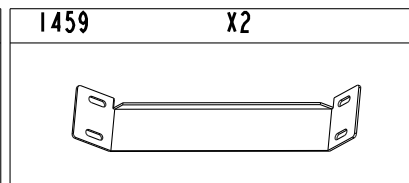
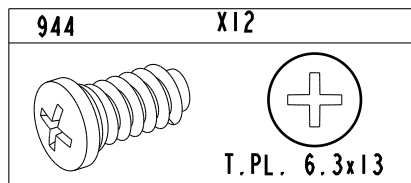
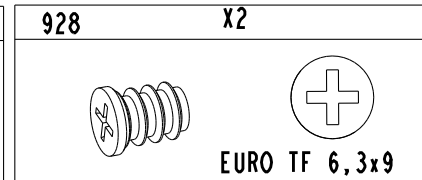
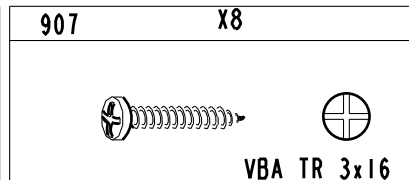
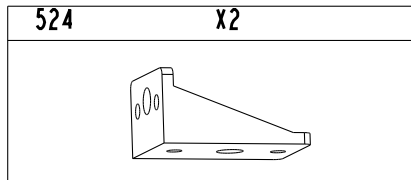
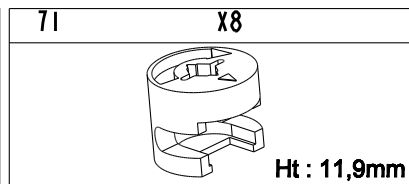
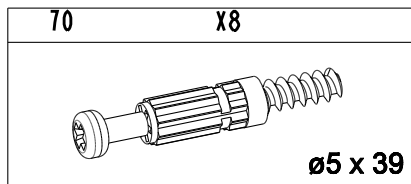
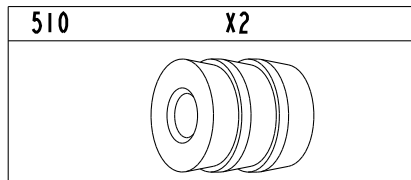
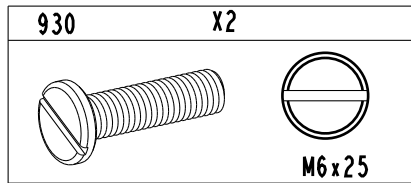
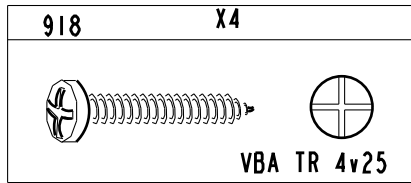
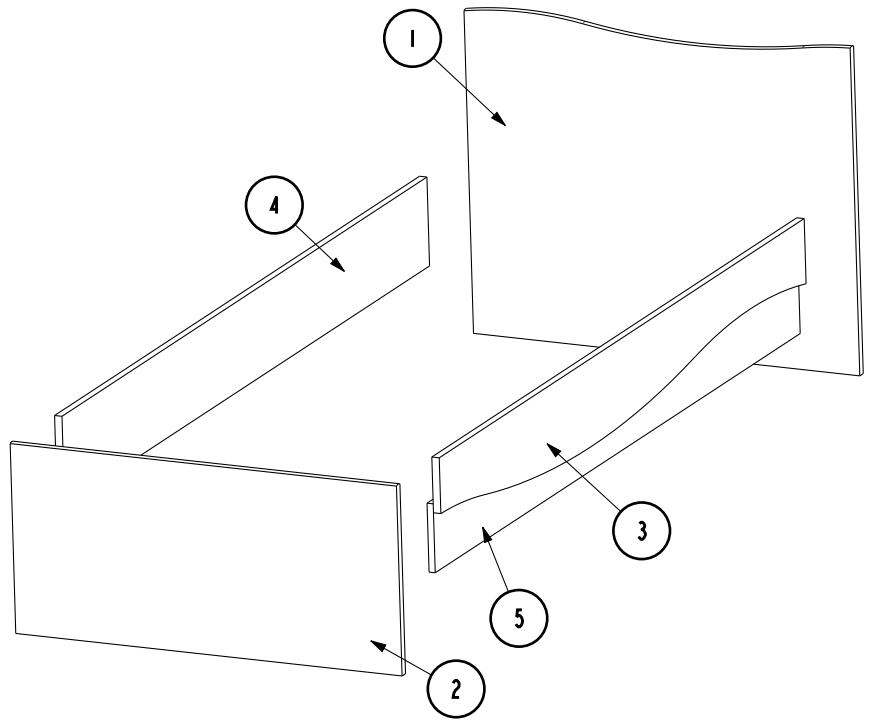

1

340057	X 4
--------	-----

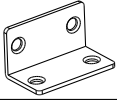

524	X 2
-----	-----

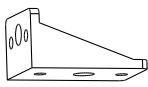



928	X 2
-----	-----



EURO TF 6,3x9

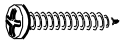

137197 0 21-Jan-10

907	X4
-----	----

VBA TR 3x16

944	X4
-----	----

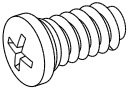

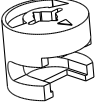

T.PL. 6.3x13

71	X 4
----	-----



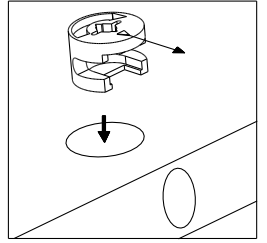
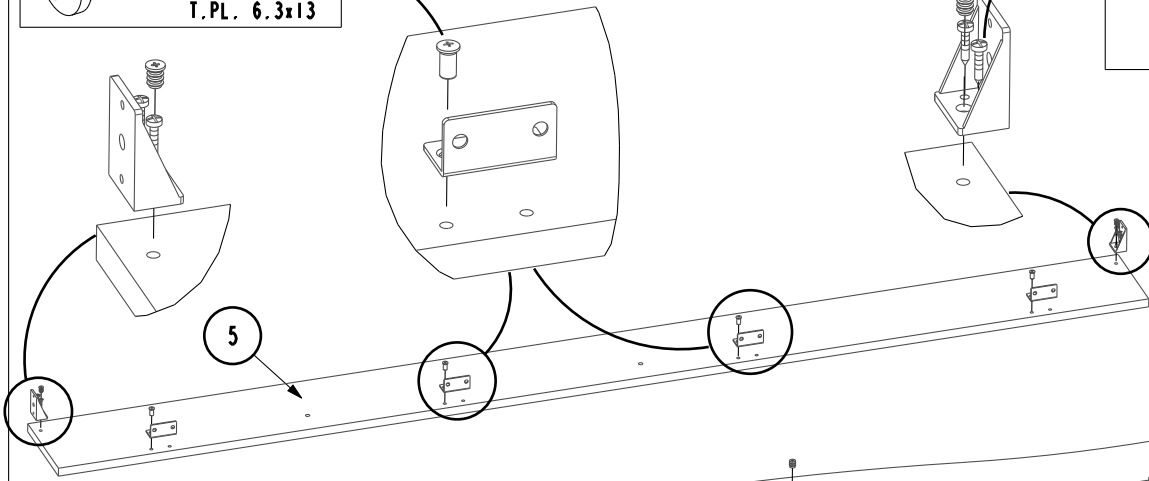

Ht : 11,9mm

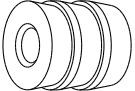

510	X 2
-----	-----



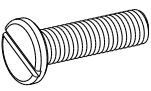

930	X 2
-----	-----

M6x25

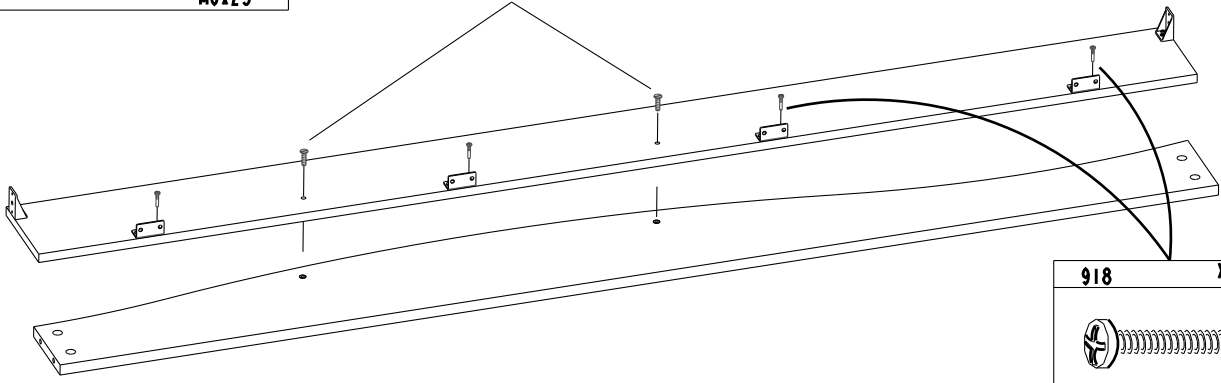
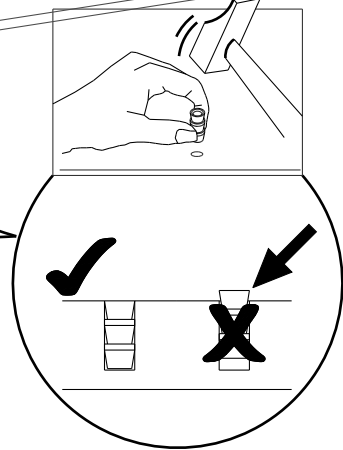

918	X4
-----	----

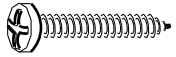

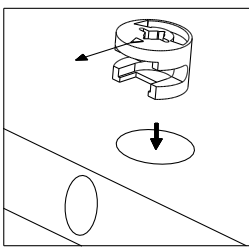

VBA TR 4x25

2

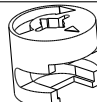

71	X 4
----	-----



Ht : 11,9mm

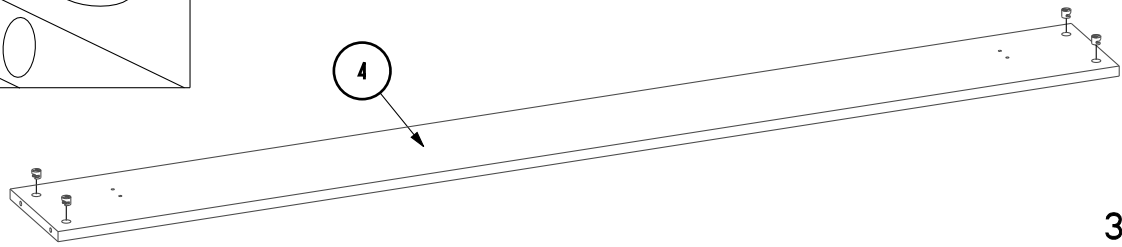

3-A

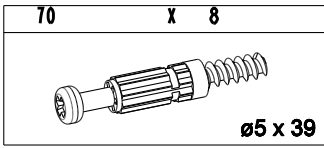

137197 0 21-Jan-10

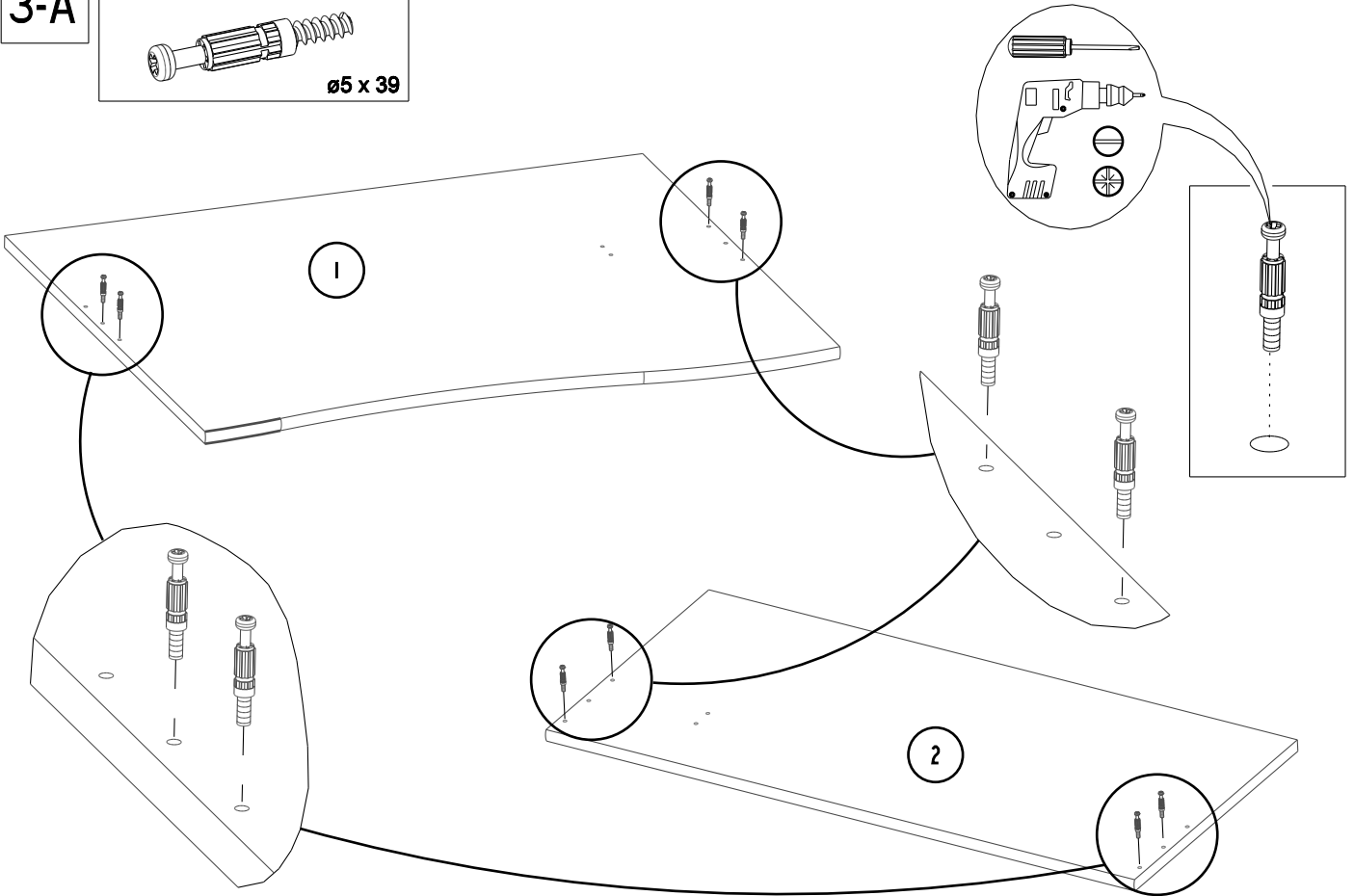

3-B

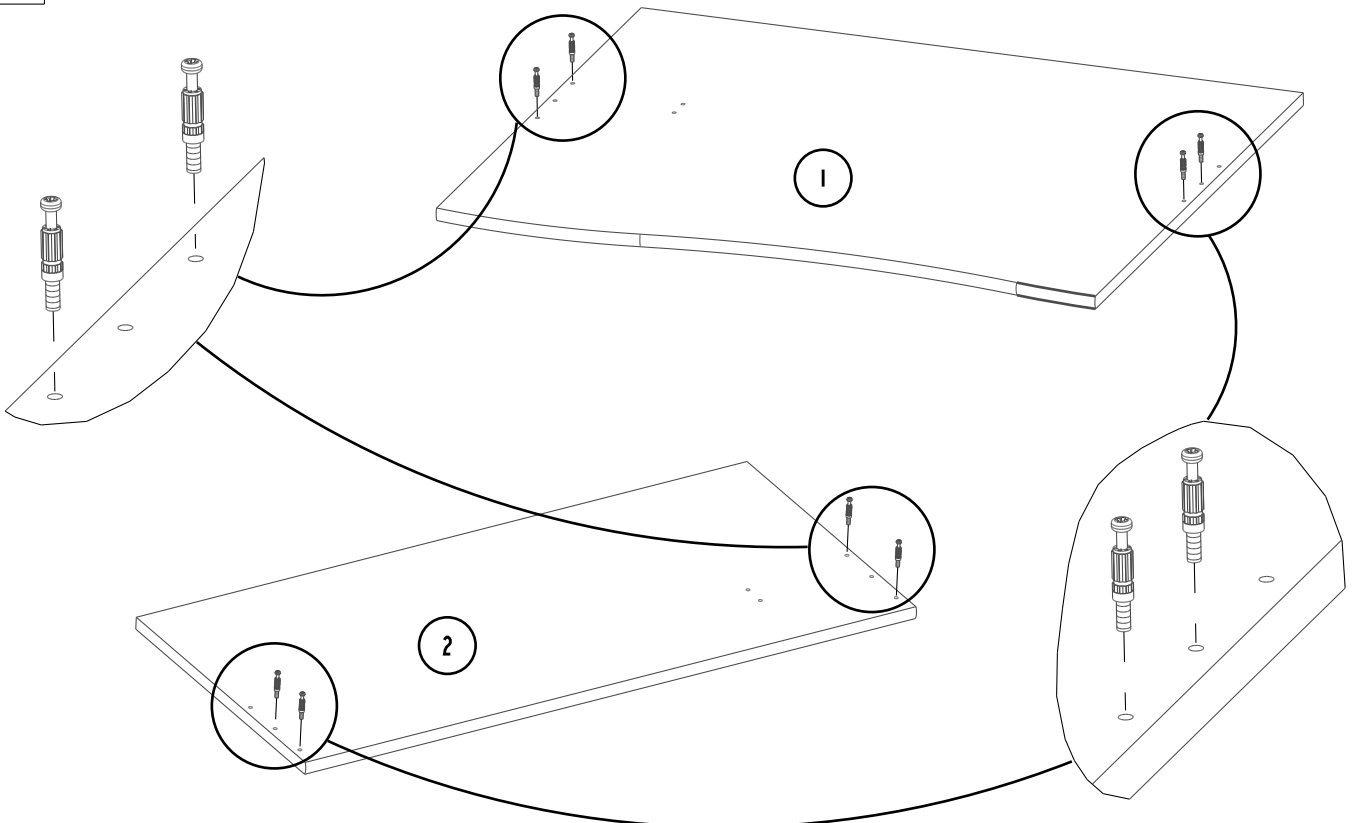

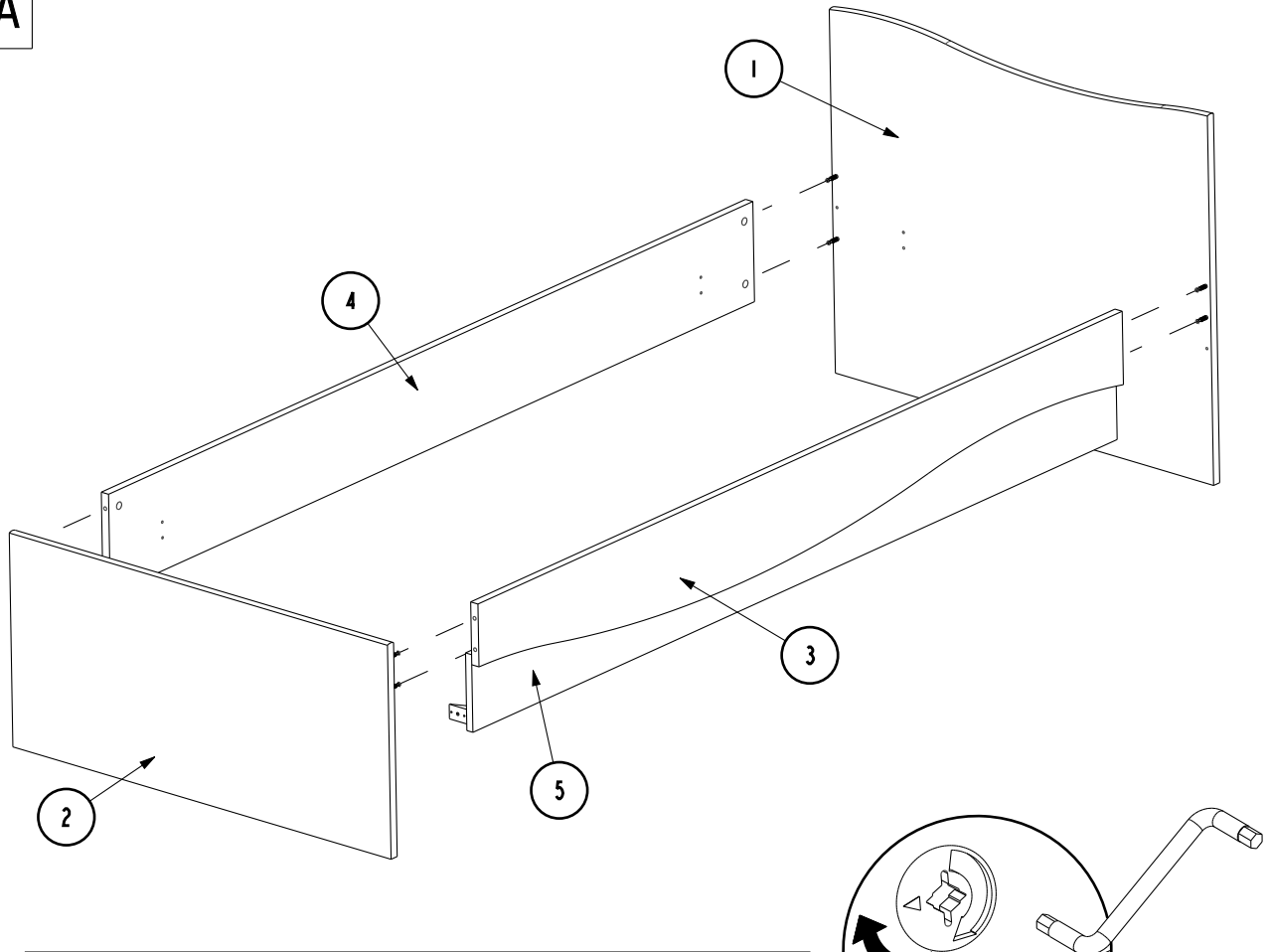

4-A



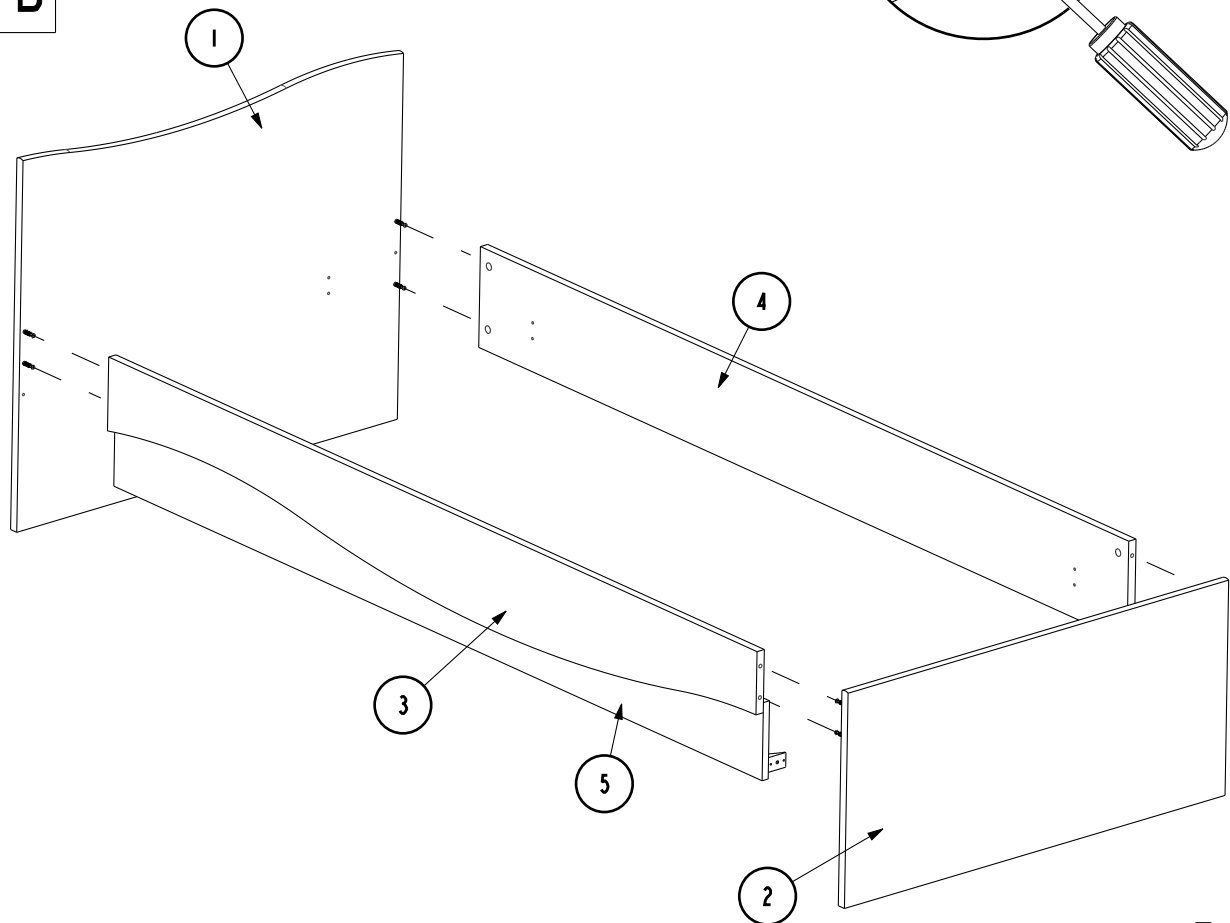

4-B

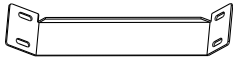
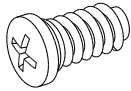

5-A

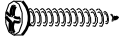
1459	X 2	944	X 8
			
		T.PL. 6.3x13	

137197 0 21-Jan-10	X 4	
907		
VBA TR 3x16		

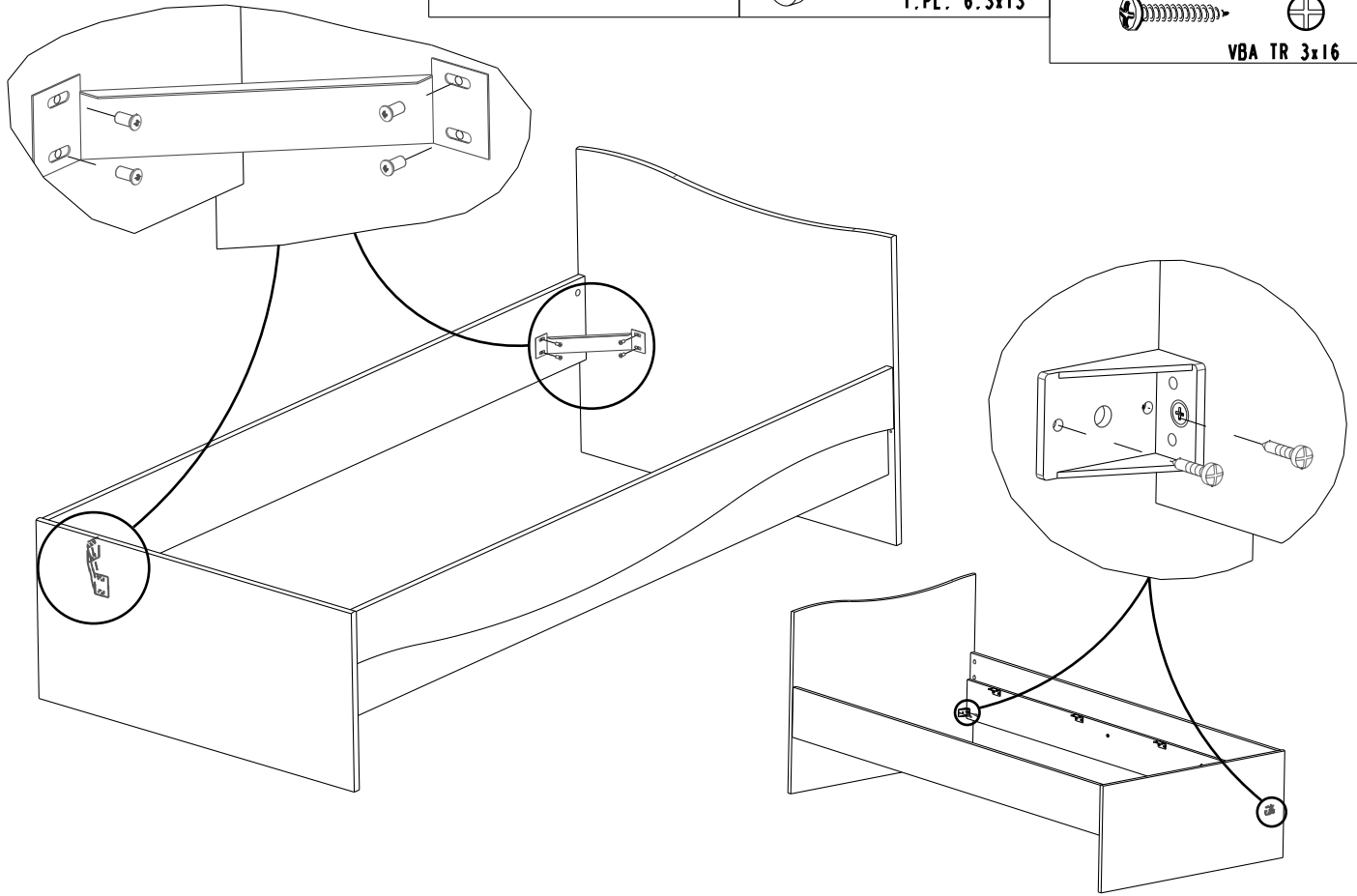

5-B

