



(GB) Assembly instructions

(PL) Instrukcja montażu

(DE) Montageanleitung

(CZ) Montážní návod

(FR) Notice de montage

(SK) Návod na montáž

(NL) Handleiding voor de montage

(HR) Montaže

(IT) Istruzioni di montaggio

(TR) Montaj talimat



(HU) Szerelési útmutató

(RO) Instrucțiuni de montaj

(ES) Instrucciones de montaje

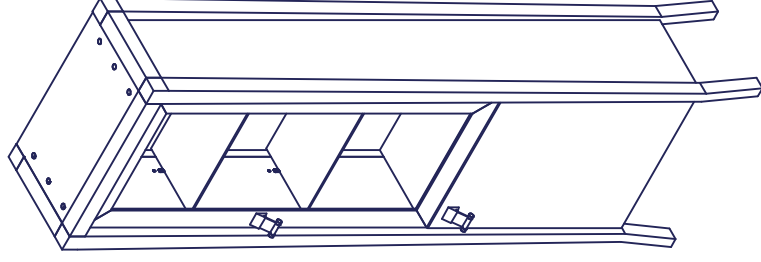
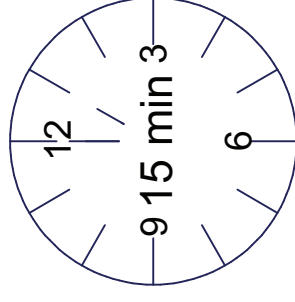
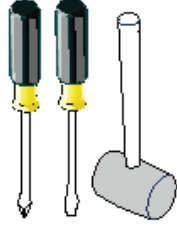
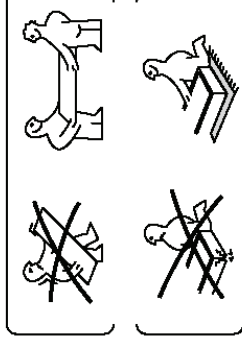
(RU) Инструкция по монтажу



	
M4x23 mm	
a11	szt 4 d4
	szt 2

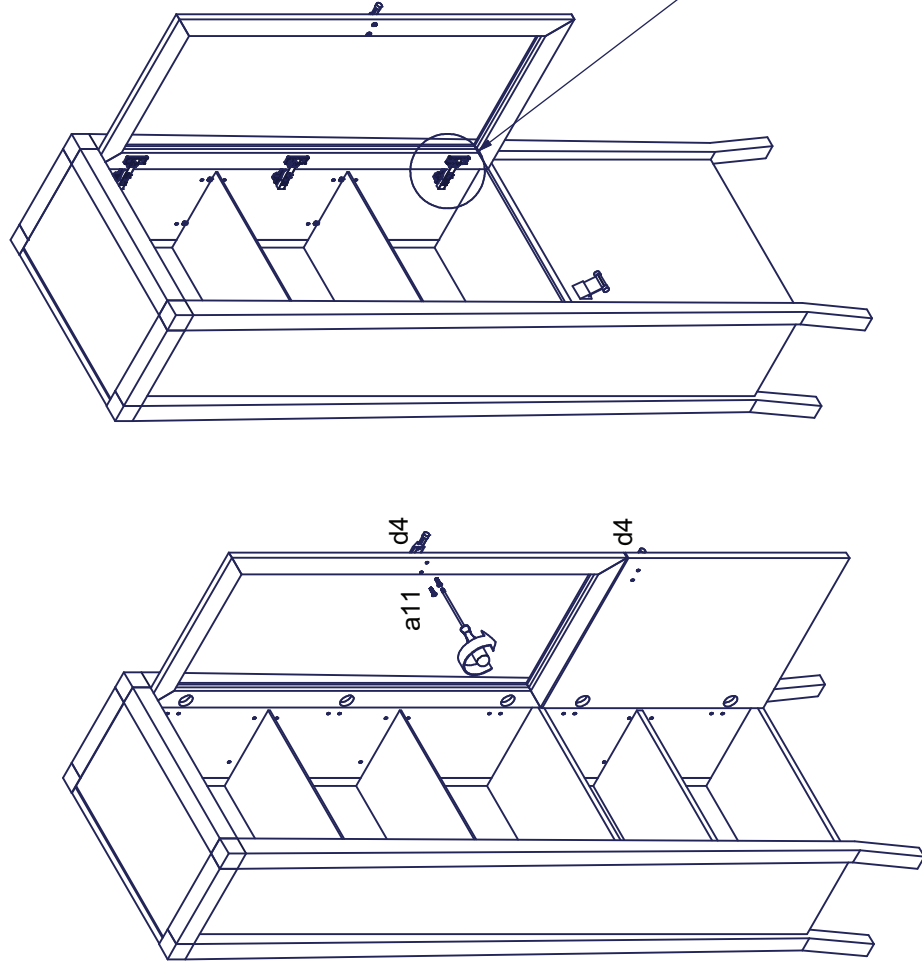

- (GB) Adjusting the doors (adjusting the hinges)
 (DE) Türen einstellen (Scharniere justieren)
 (FR) Régler les portes (ajuster les charnières)
 (IT) Sistemare le porte (regolare le cerniere)
 (NL) Deuren instellen (scharnieren afstellen)
 (PL) Nastawić drzwi (wyregulować zawiasy)
 (SK) Vyrovnajte dvířka (sěřit' te závěsy)
 (CZ) Nastavenie dverí (nastavenie závesov)
 (HU) Állítsa be az ajtókat (állítsa be a zsanérokat)
 (RO) Reglare uș i (ajustare balamale)
 (TR) Kapıların ayarlanması (mente şelerin seviye ayar)
 (HR) Postavite vrata (podešavanje šarke)
 (ES) Coloque la puerta (ajustar las bisagras)
 (RU) Діаоёчдіаєр ааідіє (Діаоёчдіаєр ірдічдр)

